



education
MPUMALANGA PROVINCE
REPUBLIC OF SOUTH AFRICA

**NATIONAL
SENIOR CERTIFICATE**

GRADE 12

**LIFE SCIENCES
EASY TO SCORE MANUAL
PAPER 1
OCTOBER 2021**

This manual consist of 45 pages

MULTIPLE CHOICE QUESTIONS**REPRODUCTIVE STRATEGIES**

- 1.1.1 The following is a list of functions performed by different organs in an organism:
- (i) Protection
 - (ii) Gaseous exchange
 - (iii) Nutrition
 - (iv) Excretion
- Which ONE of the following combinations refers to the functions performed by parts of an amniotic egg?
- A (i), (ii) and (iii) only
 - B (i), (iii) and (iv) only
 - C (ii), (iii) and (iv) only
 - D (i), (ii), (iii) and (iv)
- 1.1.2 Development of the embryo inside the body of the mother, eventually leading to live birth.
- A Vivipary
 - B Ovovivipary
 - C Fertilisation
 - D Ovipary
- 1.1.3 Which one of the following structures of the amniotic egg has similar functions as the umbilical cord in gaseous exchange.
- A Amnion
 - B Allantois
 - C Yolk sac
 - D Chorion
- 1.1.4 The structure in the amniotic egg that supplies nutrients:
- A Shell
 - B Allantois
 - C Chorion
 - D Yolk sac

HUMAN REPRODUCTION (MCQ)

- 1.1.1 The structure that enables the sperm to move through the fallopian tube is the...
- A tail.
 - B nucleus.
 - C middle piece
 - D head.
- 1.1.2 Which ONE of the following is the correct sequence of events during human reproduction?
- A Oogenesis - ovulation - fertilisation - implantation
 - B Oogenesis - ovulation - implantation - fertilisation
 - C Ovulation – oogenesis - fertilisation - implantation
 - D Ovulation - oogenesis – implantation - fertilisation
- 1.1.3 The following blood vessels lead to and from the placenta in a pregnant female:
- (i) Umbilical arteries
 - (ii) Umbilical vein
 - (iii) Mother's artery
 - (iv) Mother's vein
- Which ONE of the following sets of blood vessels transport blood with a high amount of oxygen and nutrients?
- A (i) and (iii) only
 - B (ii) and (iii) only
 - C (i) and (iv) only
 - D (ii) and (iv) only
- 1.1.4 The advantage of the testes located in the scrotum, outside the body cavity:
- A More sperm can be stored in the scrotum.
 - B Sperm development is more efficient at temperatures below 36 °c.
 - C Testes are better protected in the scrotum than in the body cavity.
 - D There is more time for prostate secretions to be added to sperm
- 1.1.5 After sperm cells have been produced in humans, they are stored in the ... until maturation.
- A penis
 - B urethra
 - C epididymis
 - D seminal vesicles

- 1.1.6 Which ONE of the following parts in the diagram of a sperm cell contains a haploid number of chromosomes?

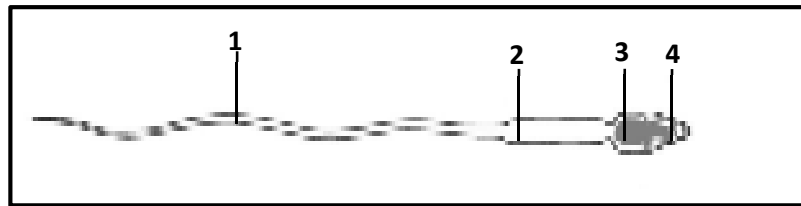

- A 1
B 2
C 3
D 4

QUESTIONS 1.1.7 AND 1.1.8 REFER TO THE INVESTIGATION BELOW.

An investigation was carried out to determine the fertility levels of healthy males in different age groups.

The procedure followed was as follows:

- 50 healthy males in each of the following age groups were asked to participate: 20–29, 30–39, 40–49, 50–59 and 60–69.
- Semen was collected from each of the males.

The number of active sperm cells present in the semen was counted for each man in each age group and averages were calculated.

- 1.1.7 Which ONE of the following is the dependent variable in the
- A Fitness levels of the males
B Age groups of the males
C Number of active sperm cells
D Amount of semen
- 1.1.8 Which ONE of the following variables was kept constant during this investigation?
- A Number of participants in each age group
B Fertility levels of males in each age group
C Number of active sperm cells
D Age groups of the males

QUESTIONS 1.1.9 AND 1.1.10 REFER TO THE GRAPH BELOW. THE GRAPH SHOWS THE CHANGES IN THE CONCENTRATION OF FEMALE HORMONES (LH AND FSH) IN TWO FEMALES DURING THE FIRST TWO WEEKS OF THE MENSTRUAL CYCLE.

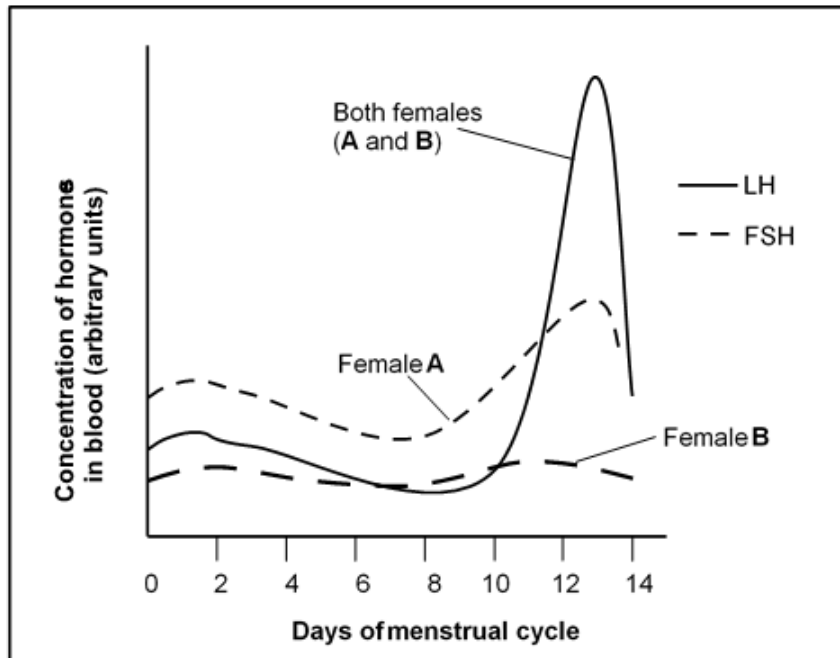

1.1.9 Which female will NOT ovulate on day 14?

- A Female **A**, because the FSH levels are high
- B Female **A**, because the LH levels are too high on day
- C Female **B**, because LH inhibits the development of a f
- D Female **B**, because a follicle did not develop in the ovary

1.1.10 Which ONE of the following statements is CORRECT regarding female **A**?

- A FSH increases on day 14 because the Graafian follicle is secreting progesterone.
- B FSH increases after day 9 as the pituitary gland/hypophysis is secreting progesterone
- C FSH decreases after day 4 to ensure that implantation occurs.
- D FSH increases in the first two days to stimulate the development of a follicle.

QUESTIONS 1.1.11 AND 1.1.12 ARE BASED ON THE DIAGRAM OF THE HUMAN MALE REPRODUCTIVE SYSTEM BELOW.

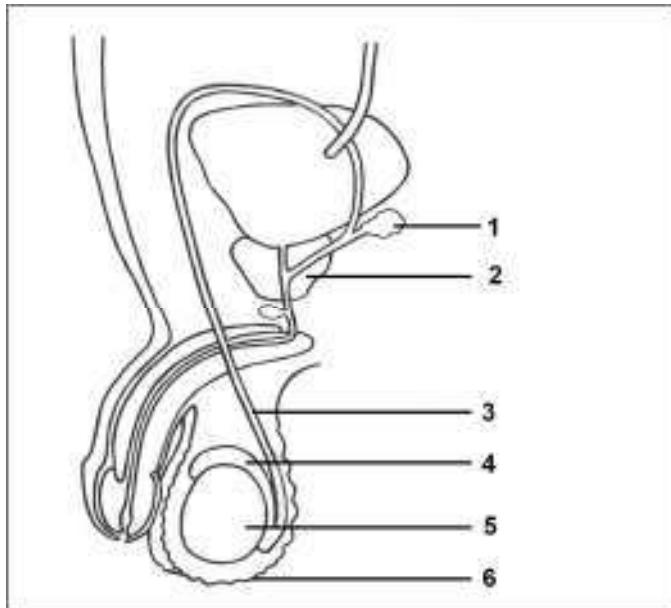

- 1.1.11 Which part stores sperm until maturation?
- A 3
 - B 4
 - C 5
 - D 6
- 1.1.12 A man who had cancer underwent surgery to remove part **1** and part **2**. The man ...
- A will be able to release semen not containing sperm and therefore cannot reproduce.
 - B cannot reproduce because he will produce abnormal sperm.
 - C cannot reproduce as his sperm will not be able to survive the acidic conditions of the vagina.
 - D will be able to reproduce but his sperm will not be able to move fast as they will not have energy.
- 1.1.13 The part of the male reproductive system where meiosis takes place is the ...
- A seminiferous tubules.
 - B seminal vesicles.
 - C urethra.
 - D epididymis.

- 1.1.14 The advantage of the testes located in the scrotum, outside the body cavity:
- A More sperm can be stored in the scrotum.
 - B Sperm development is more efficient at temperatures below 36 °C.
 - C Testes are better protected in the scrotum than in the body cavity.
 - D There is more time for prostate secretions to be added to sperm.

1.1.15 Where are sperm cells in humans temporarily stored?

- A Vas deferens
- B Epididymis
- C Urinary bladder
- D Prostate gland

1.1.16 The part of a sperm cell that contains enzymes to digest the membrane of the ovum is the ...

- A tail
- B mid-piece
- C nucleus
- D acrosome

1.1.17 A function of amniotic fluid is to ...

- A serve as a micro-filter preventing germs from entering the foetus.
- B act as a shock absorber to protect the foetus.
- C keep the foetus at a temperature lower than body temperature.
- D serve as a medium for the sperm to swim in.

1.1.18 The part of the male reproductive system where meiosis takes place is the ...

- A seminiferous tubules.
- B seminal vesicles.
- C urethra.
- D epididymis.

1.1.19 An acrosome has ...

- A mitochondria to produce energy for the movement of sperm.
- B a chromatin network that carries genes.
- C enzymes needed to penetrate the ovum.
- D a tail to facilitate the movement of sperm.

1.1.20 Ovulation is stimulated by an increase in the levels of ...

- A progesterone
- B LH
- C FSH
- D Oestrogen

1.1.21 Oogenesis takes place in the ...

- A uterus.
- B ovary.
- C cervix.
- D vagina.

HUMAN RESPONSE (MCQ)

1.1.1 The microscopic space between two adjacent neurons is a/an ...

- A axon.
- B dendrite.
- C synapse.
- D cell body.

1.1.2 An investigation was done to determine the effect of alcohol on the reaction time of a person.

Reaction time was measured by the time it took to catch a ruler.

The procedure was as follows:

- The person's reaction time was first measured in a room with bright light.
- The person was then given 200 ml of alcohol to drink.
- After 15 minutes the reaction time of the person was measured for the second time while he/she was in a room with dim light.
- Ten measurements were recorded each time and an average was calculated.

How was the validity of the investigation decreased?

- A The person's reaction time was measured in the absence of alcohol the first time.
- B Reaction time was measured by the time it took to catch a ruler.
- C Reaction time was measured in different light conditions.
- D Only ten measurements were recorded.

1.1.3 Which ONE of the following represents the CORRECT combination of a visual defect, its nature and the corrective measure?

	VISUAL DEFECT	NATURE OF DEFECT	CORRECTIVE MEASURE
A	Cataracts	Curvature of lens is uneven	Biconcave lenses
B	Short-sightedness	Lens cannot become less convex	Biconcave lenses
C	Astigmatism	Lens cannot become more convex	Surgery
D	Long-sightedness	Lens becomes cloudy and opaque	Biconvex lenses

- 1.1.4 The graph below shows the curvature of the human lens when viewing objects at different distances.

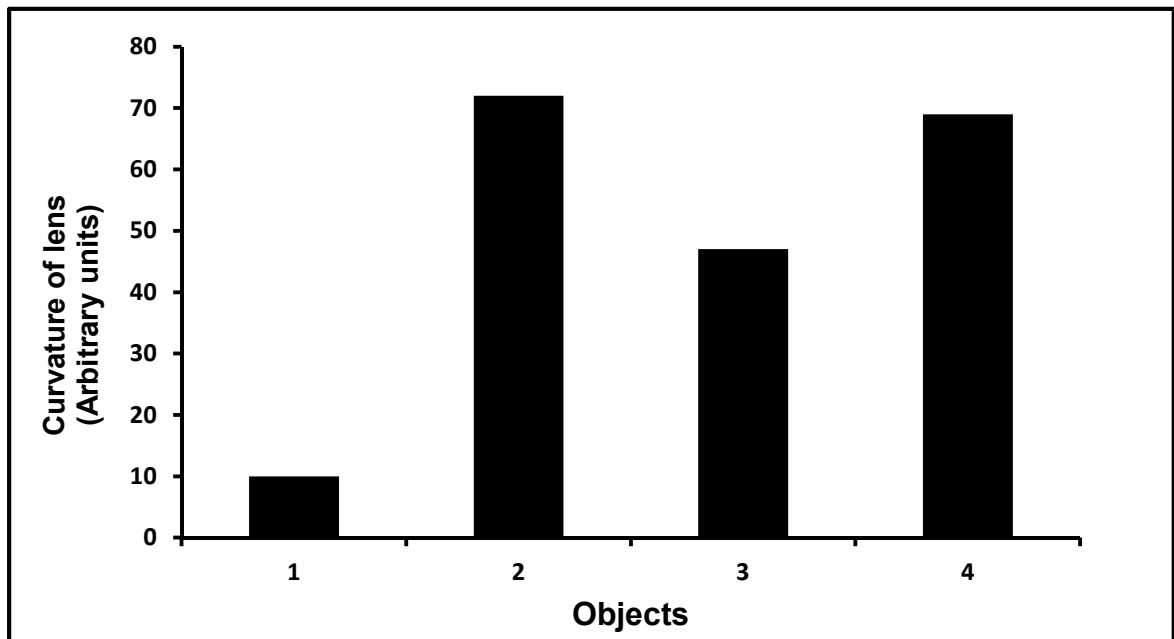

Which ONE of the following objects is closest to the human eye?

- A 1
 - B 2
 - C 3
 - D 4
- 1.1.5 The part of the brain that receives nerve impulses from the semi-Circular canals is the ...
- A cerebrum.
 - B cerebellum.
 - C hypothalamus.
 - D medulla oblongata

1.1.6 A light stimulus is converted into a nerve impulse in the ...

- A iris.
- B retina.
- C optic nerve.
- D sclera.

1.1.7 Which ONE of the following statements is CORRECT regarding the eyes represented in the diagrams below?

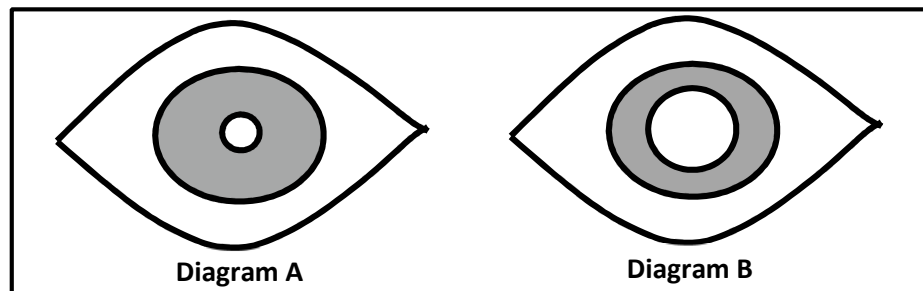

- A Diagram **A** is looking at an object closer than 6 metres, while diagram **B** is looking at an object further than 6 metres.
- B Diagram **A** is looking at an object further than 6 metres, while diagram **B** is looking at an object closer than 6 metres.
- C The eye in diagram **A** is in dim light and the eye in diagram **B** is in bright light.
- D The eye in diagram **A** is in bright light and the eye in diagram **B** is in dim light.

1.1.8 The diagram below shows a reflex arc.

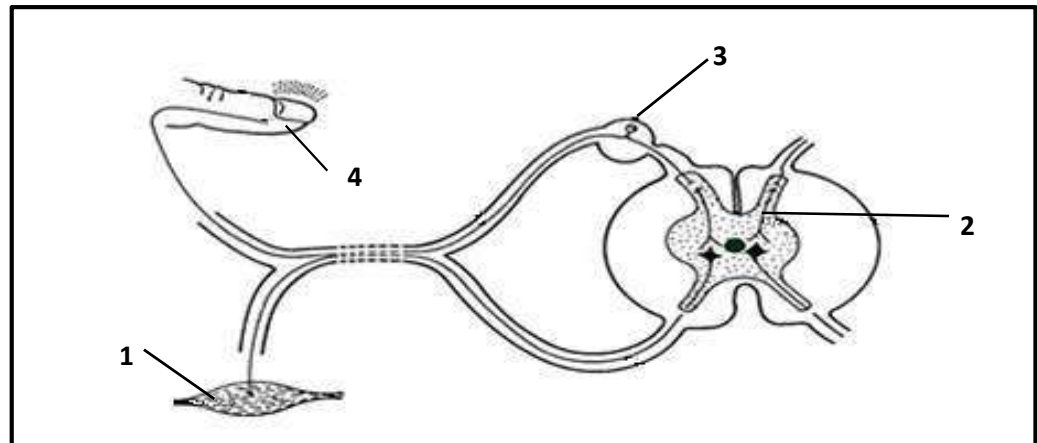

Which part represents the effector?

- A 4
- B 1
- C 3
- D 2

1.1.9 A person with middle-ear infection is usually advised not to fly in an aeroplane because the ...

- A maculae in the semi-circular canals are unable to receive the stimulus.
- B round window is unable to absorb sound waves, leading to echoes.
- C Eustachian tube is unable to equalise the pressure on either side of the tympanic membrane.
- D optic nerve will be damaged, leading to hearing loss.

1.1.10 A function of the iris of the eye is to ...

- A refract light to form a clear image.
- B control the amount of light that enters the eye.
- C convert the light stimuli into impulses.
- D prevent reflection of light within the eye.

- 1.1.11 Diagram **A** and diagram **B** below represent the same part of the same human eye under different conditions.

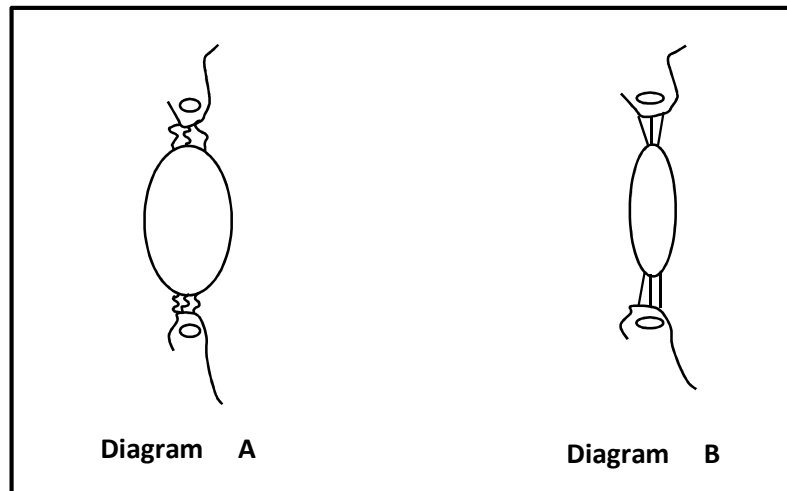

Which diagram, with a corresponding reason, represents a person looking at an object 10 metres away?

- A Diagram **A** because the suspensory ligaments are taut/tight and the lens is less convex
 B Diagram **A** because the lens is more convex and the suspensory ligaments are slack
 C Diagram **B** because the lens is more convex and the suspensory ligaments are slack
 D Diagram **B** because the suspensory ligaments are taut/tight and the lens is less convex
- 1.1.12 The nerve impulse in the axon of a sensory neuron is transmitted ...

- A towards the dendrite of the sensory neuron.
 B towards the cell body of the sensory neuron.
 C away from the effector organ.
 D away from the cell body.

- 1.1.13 Which part of the ear converts pressure waves into nerve impulses?

- A Auditory nerve
 B Organ of Corti
 C Eustachian tube
 D Auditory canal

- 1.1.14 A person can feel pain in his legs but cannot move his legs.

This is a result of damage to the ...

- A sensory neuron.
- B sensory and motor neuron.
- C motor neuron.
- D sensory and interneuron.

1.1.15 Colour vision is difficult at night, because under dim light conditions ...

- A rods are not stimulated.
- B the pupil dilates.
- C cones are not stimulated.
- D the lens cannot change shape.

1.1.16 The table below indicates the effect of drinking different amounts of alcohol on the reaction times of a group of people.

The reaction time was determined by using the catch distance on a ruler that was dropped from a certain height.

The longer the catch distance on the ruler, the longer the reaction time.

Units of alcohol (5% per volume)	0	1	2	3	4	5	6
Catch distance on the ruler (cm)	14	12	10	18	22	25	29

The conclusion that can be drawn from the investigation is that drinking alcohol ...

- A increases the reaction time.
- B initially increases the reaction time, after which further intake of alcohol decreases the reaction time.
- C does not have any effect on the reaction time.
- D initially decreases the reaction time, after which further intake of alcohol increases the reaction time.

- 1.1.17 The table below shows the speed at which impulses are transmitted through different types of nerve fibres, **A**, **B**, **C** and **D**.

NERVE FIBRE	DIAMETER (μm)	AVERAGE SPEED OF TRANSMISSION (m/s)
A	15	100
B	7	19
C	3	13
D	1	1

Which ONE of the following is the best interpretation of the information in the table above?

- A Nerve fibre **A** is found in patients suffering from multiple sclerosis.
- B The speed of transmission of impulses is not important for the survival of an individual.
- C The greater the diameter of the nerve fibre, the greater the speed of transmission.
- D Nerve fibre **D** is found in patients suffering from Alzheimer's disease.

- 1.1.18 Which part of the neuron transmits impulses towards the cell body?

- A Dendrite
B Myelin sheath
C Axon
D Synapse

- 1.1.19 Which part of the ear contains the receptors for hearing?

- A Cochlea
B Tympanic membrane
C Oval window
D Round window

- 1.1.20 Which ONE of the following is a consequence if the round window of the ear hardens?
- A Pressure waves will not be created.
 - B Impulses will not be transmitted to the brain.
 - C Pressure between the outer and the middle ear will not be equalised.
 - D An echo will occur and the sound will be distorted.
- 1.1.21 Which part controls the amount of light entering the eye?
- A Cornea
 - B Iris
 - C Choroid
 - D Lens
- 1.1.22 Which ONE of the following is CORRECT with regard to astigmatism?
- A Light cannot pass through the cornea
 - B Light cannot pass through the lens
 - C Refraction of light rays by the cornea is uneven
 - D The lens cannot become more rounded
- 1.1.23 Which ONE of the following shows the correct sequence of an impulse from the receptor in a simple reflex arc?
- A Sensory neuron through the dorsal root → motor neuron through the ventral root → effector
 - B Motor neuron through the dorsal root → sensory neuron through the ventral root → effector
 - C Sensory neuron through the dorsal root → effector → motor neuron through the ventral root
 - D Effector → interneuron through the dorsal root → motor neuron through the ventral root
- 1.1.24 Nocturnal animals have the ability to see clearly in the dark. They have ...
- A bigger eyes.
 - B more rods in the retina.
 - C more cones in the retina.
 - D no blind spot.

1.1.25 A list of the functions of the brain is provided below:

- (i) Interprets sensation
- (ii) Regulates involuntary actions
- (iii) Controls higher thought processes
- (iv) Controls voluntary actions

Which ONE of the following combinations are the functions of the cerebrum?

- A (ii) and (iii) only
- B (i), (ii), (iii) and (iv)
- C (i), (iii) and (iv) only
- D (i) and (ii) only

1.1.26 Barotrauma is a common condition that occurs when pressure builds up in the middle ear. This causes the tympanic membrane to bulge. It is most common among deep-sea divers.

Divers are advised against diving when they have a middle-ear infection because the ...

- A auditory canal cannot equalise the pressure in the middle ear.
- B Eustachian tube is blocked and air cannot enter the middle ear.
- C tympanic membrane is hardened and cannot pass the vibrations onto the middle ear.
- D ossicles are fused together and cannot vibrate freely in middle ear

1.1.27 A learner conducted an investigation to determine the effect of caffeine on reaction time.

The procedure was done as follows:

- 50 male volunteers of the same age participated.
- Their reaction times were measured using a computer program.
- They were all given 200 ml of an energy drink that contained caffeine.
- Their reaction times were measured again every 10 minutes for 2 hours.

Which ONE of the following increased the reliability of the results obtained?

- A Gender of the volunteers
- B Age of the volunteers
- C 50 volunteers used
- D Type of caffeine used

PLANT RESPONSE (MCQ)

- 1.1.1 The graph below shows the effect of different concentrations of gibberellins on the germination of seeds.

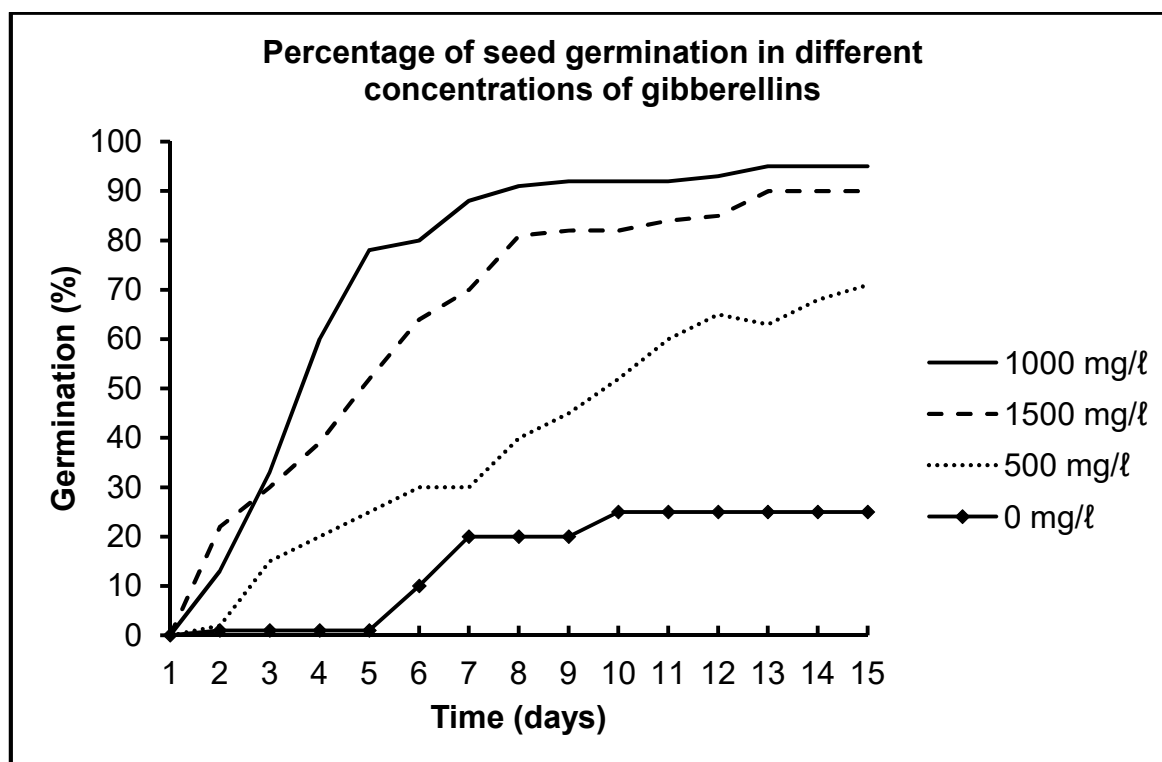

[Adapted from *HortScience* 44(3)]

One possible conclusion drawn from the results shown above, is that the ...

- A gibberellin concentration has no effect on the germination of the seeds.
- B highest percentage of seed germination occurs at a gibberellin concentration of 1 500 mg/l.
- C highest percentage of seed germination occurs at a gibberellin concentration of 1 000 mg/l.
- D lowest percentage of seed germination occurs at a gibberellin concentration of 1000 mg/l.

- 1.1.2 A gardener removes the apical buds from a rose bush in her garden regularly. As a result the rose bush will ...
- A produce more lateral branches.
 - B grow taller.
 - C remain the same size.
 - D produce fewer roses.
- 1.1.3 Which ONE of the following plant hormones is responsible for the germination of seeds?
- A Growth hormone
 - B Abscisic acid
 - C Gibberellin
 - D Auxin
- 1.1.4 Which of the following are plant growth hormones?
- A Prolactin and abscisic acid
 - B Abscisic acid and glucagon
 - C Gibberellins and abscisic acid
 - D ADH and gibberellins
- 1.1.5 An investigation was done in which a potted plant was placed horizontally on a clinostat, as shown in the diagram. The plant was exposed to uniform light from all directions.
- (A clinostat is a device with a disc that rotates when switched on, allowing the attached plant to rotate as well.)

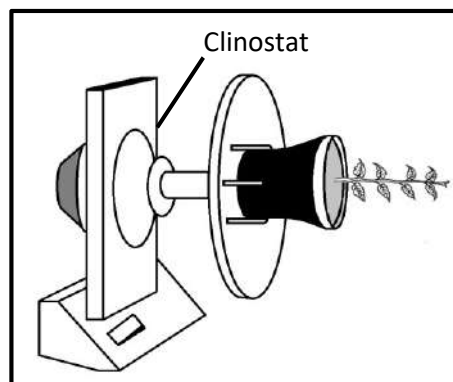

The stem grew vertically upwards, which indicates that the clinostat was ...

- A stationary and the stem showed negative geotropism.
- B rotating and the stem showed positive geotropism.
- C stationary and the stem showed negative phototropism.
- D rotating and the stem showed positive phototropism.

ENDOCRINE SYSTEM AND HOMEOSTASIS (MCQ)**QUESTIONS 1.1.1 AND 1.1.2 REFER TO THE INVESTIGATION BELOW.**

A scientist did an investigation on a healthy individual to determine the effect of drinking water on urine production.

The participant was requested not to eat or drink for four hours before the investigation began. The investigation was conducted over a period of three days.

The procedure was as follows:

- On day 1 the participant was given 600 ml of water to drink.
- On day 2 the participant was given 800 ml of water to drink.
- On day 3 the participant was given 1 000 ml of water to drink.
- For each day the amount of urine produced by the participant was measured and recorded over the next four hours, and an average was calculated.

1.1.1 Which ONE of the following CORRECTLY indicates the dependent and the independent variables?

	INDEPENDENT VARIABLE	DEPENDENT VARIABLE
A	The amount of urine produced	Time in hours
B	The amount of water drunk	The amount of urine produced
C	The amount of urine produced	The amount of water drunk
D	The people participating	Time in hours

1.1.2 The list below contains some steps taken before and during the investigation.

- (i) Permission was obtained to participate in the investigation.
- (ii) The measuring tool to be used was decided upon.
- (iii) Water was given to the participant to drink.
- (iv) The amount of urine produced was measured.

Which of the steps above can be considered as part of the planning steps before conducting the investigation?

- A (i), (ii), (iii) and (iv)
- B (i) and (ii) only
- C (ii), (iii) and (iv) only
- D (iii) only

- 1.1.3 The graph below shows the relationship between the production of growth hormone and age.

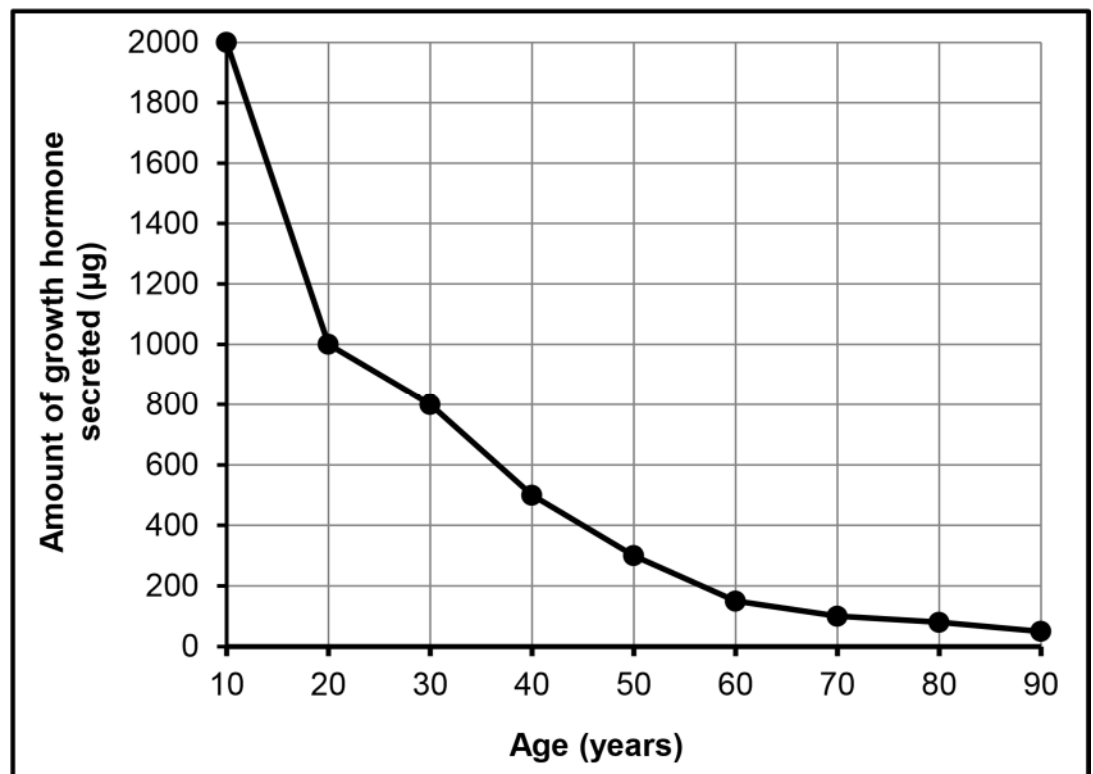

A general conclusion that can be drawn from the results is that ...

- A growth hormone is not secreted after the age of 50 years.
- B the amount of growth hormone secreted decreases with age.
- C the amount of growth hormone secreted increases with age.
- D the amount of growth hormone secreted remains stable over time.

- 1.1.4 When Jane plays in the snow, her body maintains a constant core temperature by ...

- A vasodilation and sweating.
- B vasoconstriction and shivering.
- C sweating and shivering.
- D vasoconstriction and vasodilation

- 1.1.5 Which ONE of the following hormones prepares the human body to react to emergency situations?

- A Insulin
- B Aldosterone
- C Adrenalin
- D Growth hormone

1.1.6 A scientist designed an investigation to test the following:

Eating more salt will decrease urine production and increase water consumption.

The table below shows the results of the investigation.

AMOUNT OF SALT CONSUMED (g)	VOLUME OF URINE PRODUCED (mℓ)	AMOUNT OF WATER CONSUMED (mℓ)
3	1 803	2 800
6	1 800	2 700
9	1 805	2 600
12	1 802	2 500
15	1 801	2 400

A possible conclusion from the results above is that eating more salt ...

- A decreases urine production and increases the amount of water consumed.
- B increases urine production and decreases the amount of water consumed.
- C has little effect on urine production and decreases the amount of water consumed.
- D has little effect on urine production and increases the amount of water consumed.

1.1.7 During periods when the temperature is low...

- A the thyroxin levels are expected to be low.
- B sweating increases.
- C the blood vessels to the skin dilate.
- D the ADH levels are expected to be low.

1.1.8 The level of aldosterone will most likely increase after ...

- A consuming food with a high salt content.
- B sweating excessively.
- C consuming food with a high glucose content.
- D the constriction of blood vessels to the skin.

1.1.9 Which ONE of the following hormones controls metabolic rate?

- A Testosterone
- B Thyroxin
- C Growth hormone
- D Insulin

1.1.10 Which ONE of the following will occur in the human body on a cold day?

- A Vasodilation in the skin
- B Increase in the activity of sweat glands
- C Decrease in evaporation of sweat from the surface of the skin
- D Increase in blood flow to the surface of the skin

1.1.11 Which ONE of the following is CORRECT regarding the homeostatic control of glucose in the human body?

	GLAND	HORMONE SECRETED	EFFECT ON BLOOD GLUCOSE LEVEL
A	Pancreas	Insulin	Increase
B	Pituitary	Glucagon	Increase
C	Pancreas	Insulin	Decrease
D	Pancreas	Glucagon	Decrease

1.1.12 Which ONE of the following is an exocrine gland?

- A Pituitary
- B Prostate
- C Adrenal
- D Thyroid

1.1.13 Which ONE of the following shows the correct combination of the hormone with its target organ?

	HORMONE	TARGET ORGAN
A	Prolactin	Pituitary gland
B	Glucagon	Pancreas
C	LH	Uterus
D	TSH	Thyroid gland

BIOLOGICAL TERMS**REPRODUCTIVE STRATEGIES**

Give the correct **biological term** for EACH of the following descriptions.

- 1.1.1 The type of egg produced by reptiles that has extra-embryonic membranes
- 1.1.2 The type of development in birds where the hatchlings' eyes are open and their bodies are covered with down feathers
- 1.1.3 The structure in the amniotic egg that stores wastes
- 1.1.4 A type of reproduction in humans where the foetus develops inside the uterus
- 1.1.5 A reproductive strategy where an organism lays eggs.
- 1.1.6 The type of development in birds where the young are practically fully developed and immediately mobile when they are hatched.
- 1.1.7 A behavioural pattern where the parents spend time and energy on the feeding and protection of their offspring.
- 1.1.8 A type of fertilisation in which the nucleus of a sperm fuses with the nucleus of an ovum outside the body of the female
- 1.1.9 An egg containing four extra-embryonic membranes.
- 1.1.10 Production of offspring that are born helpless, unable to move and feed themselves.

HUMAN REPRODUCTION

- 1.1.1 A hollow ball of cells formed from the zygote
- 1.1.2 The finger-like projections that develop from the outer extra-embryonic membrane
- 1.1.3 A structure in the female reproductive system where semen is deposited during copulation
- 1.1.4 The period of development of the foetus in the uterus
- 1.1.5 A structure in the female reproductive system where fertilisation takes place
- 1.1.6 The stage when secondary sexual characteristics develop in males and females
- 1.1.7 A hormone that stimulates ovulation in humans
- 1.1.8 The blood vessel that transports deoxygenated blood from the foetus towards the placenta
- 1.1.9 A part of the male reproductive system used to transfer semen to the female
- 1.1.10 The structure that the Graafian follicle develops into after ovulation
- 1.1.11 The hormone that stimulates puberty in females
- 1.1.12 The inner lining of the uterus where implantation of the embryo occurs
- 1.1.13 A hormone that stimulates the maturation of sperm and puberty in males

- 1.1.14 The tube in the male reproductive system that connects the epididymis with the urethra
- 1.1.15 The diploid cell formed by the process of fertilisation
- 1.1.16 A fluid that protects the human embryo against injuries and large-scale temperature changes
- 1.1.17 A blood vessel in the umbilical cord that transports nutrients to the foetus
- 1.1.18 The formation of ova from the germinal epithelial cells through the process of meiosis.
- 1.1.19 The process whereby the embryo becomes attached to the endometrial wall of the uterus.
- 1.1.20 The blood vessel that carries oxygenated blood to the foetus.
- 1.1.21 The period during which the embryo develops within the uterus of the mother up to the time the baby is born.
- 1.1.22 The three-month-old human embryo
- 1.1.23 The membrane that forms finger-like projections which grows into the uterine wall.
- 1.1.24 The liquid that protects the embryo against mechanical injury and dehydration.
- 1.1.25 Structure in the sperm cell containing enzymes that break down the membrane of the ovum.
- 1.1.26 The release of an ova from the follicle.
- 1.1.27 The tube that transports the sperm from the testis to the urethra.
- 1.1.28 A hormone produced in females to stimulate milk production.
- 1.1.29 The structure formed from the Graafian follicle after ovulation.
- 1.1.30 The process by which sperms and eggs are produced.
- 1.1.31 The organ in males in which meiosis occurs.
- 1.1.32 A fluid containing sperm cells.
- 1.1.33 The meiotic process by which female gametes are formed in humans
- 1.1.34 The blood vessel in the umbilical cord which is rich in oxygen and nutrients.
- 1.1.35 The outermost extra-embryonic membrane surrounding the embryo.
- 1.1.36 A stage in the development of humans in which the embryo consist of a layer of cells surrounding a cavity.
- 1.1.37 The gland in the male reproductive system of humans that produces an alkaline fluid to counteract the acid environment of the vagina.
- 1.1.38 The hormone produced by the Graafian follicle.
- 1.1.39 The hormone responsible for the formation of the corpus luteum.
- 1.1.40 The stage in humans when sexual maturity is reached in males and females.
- 1.1.41 A hormone that stimulates the maturation of sperm.
- 1.1.42 A type of egg where the embryo develops inside a fluid-filled sac which is surrounded by a shell.
- 1.1.43 The place where young immature sperm cells are temporarily stored in males until they mature.
- 1.1.44 Part of the female reproductive system where fertilisation occurs.

- 1.1.45 The vesicle which contains enzymes found in the head of the sperm cell.
- 1.1.46 The fluid in which the human foetus grows and develops.
- 1.1.47 Duct connecting the ovaries to the uterus in female.
- 1.1.48 The term used for a human baby in the first seven weeks from conception.
- 1.1.49 The process where the blastula settles on the endometrium and attaches itself to it.
- 1.1.50 The cell division by which the zygote becomes multicellular.
- 1.1.51 Hormone that maintains pregnancy.
- 1.1.52 A type of reproduction in humans where the foetus develops inside the uterus
- 1.1.53 Combination of embryonic and material tissue responsible for gas exchange, nutrition and excretion.
- 1.1.54 The process by which the ovum is formed through meiosis in the ovary.
- 1.1.55 A temporary organ that connects the developing foetus through the umbilical cord to the uterine wall.

HUMAN RESPONSE TO THE ENVIRONMENT

- 1.1.1 Nerve fibres that conduct nerve impulses away from the cell body of a neuron.
- 1.1.2 A functional (physiological), but not direct, connection between two successive neurons.
- 1.1.3 A disorder that occurs when one's own immune system surrounds, attacks and destroys the myelin sheath that envelops the axon.
- 1.1.4 The membranes which protect the central nervous system.
- 1.1.5 The nervous system which consists of cranial and spinal nerves.
- 1.1.6 A branch of autonomic nervous system that decreases the heartbeat back to normal.
- 1.1.7 The cells, in the retina of the eye that is sensitive to light.
- 1.1.8 The tube that connects the middle ear to the throat cavity to ensure that the pressure on either side of the tympanic membrane is kept constant.
- 1.1.9 Defect of the eye due to a clouding of the eye's normal, clear, transparent lens, affecting acuity of vision.
- 1.1.10 A rapid, automatic response to a stimulus.
- 1.1.11 The structure, within the cochlea, responsible for the conversion of a sound stimulus into an impulse.
- 1.1.12 Microscopic space between two consecutive neurons.
- 1.1.13 The part of the nervous system outside the brain and spinal cord
- 1.1.14 Neurons that carry impulses from receptors.

- 1.1.15 The receptors in the ear that detects changes in the direction and speed and any movement of the body.
- 1.1.16 The series of changes that takes place in the shape of the lens and the eyeball in response to the distance of an object from the eye.
- 1.1.17 Small tubes placed in the tympanic membrane to drain liquid from the middle ear.
- 1.1.18 Part of the human ear that directs sound waves into the auditory canal.
- 1.1.19 The part of the brain that controls the heart rate.
- 1.1.20 The part of the peripheral nervous system that controls involuntary actions.
- 1.1.21 A disorder of the eye caused by the curvature of the lens or cornea being uneven, resulting in distorted images.
- 1.1.22 A part of the retina where no photoreceptors are found.
- 1.1.23 Large bundle of nerves connecting the left and right hemispheres of the brain.
- 1.1.24 The cells or sense organ that receives a stimulus.
- 1.1.25 The structure that connects the left and right hemispheres of the brain, allowing communication between them.
- 1.1.26 The nerve that carries impulses from the retina to the brain.
- 1.1.27 Collective name for the membranes that protect the brain and spinal cord.
- 1.1.28 Path taken by an impulse during a reflex action.
- 1.1.29 A pigmented layer in the eye which absorbs light and prevent its reflection.
- 1.1.30 Changes that occur in the diameter of the pupil under different light conditions.
- 1.1.31 Neuron that transmit impulses from the sensory neuron to the motor neuron.
- 1.1.32 The ability of the lens of the eye to alter its shape for clear vision.
- 1.1.33 Tube that connects the pharynx and the middle ear.
- 1.1.34 The structural unit of the nervous system.
- 1.1.35 The iris muscles that contract in dim light

PLANT RESPONSE TO THE ENVIRONMENT

- 1.1 A plant growth hormone that stimulates seed germination.
- 1.2 The movement of part of a plant in response to gravity.
- 1.3 The plant growth hormone that promotes seed dormancy.
- 1.4 A plant hormone that causes leaves to fall off trees in autumn.
- 1.5 A plant growth response to an external stimulus.
- 1.6 Inhibition of the growth of lateral buds by the auxins present in apical buds.
- 1.7 Plant growth substances that is responsible for the elongation of internodes in plants.
- 1.8 Growth or bending reaction by plants in response to light.
- 1.9 A plant hormone that promotes bud, flowers and fruit development.

ENDOCRINE SYSTEM AND HOMEOSTASIS

- 1.1 A phenomenon where an increase in one hormone inhibits the secretion of another hormone.
- 1.2 A disease in which the hormonal control of blood glucose is defective because of a deficiency of insulin.
- 1.3 The increase of the internal diameter of blood vessels so that more blood flows through them.
- 1.4 The hormone that regulates the salt concentration in the human body.
- 1.5 The maintenance of a constant internal environment in living organisms.
- 1.6 A hormone which stimulates the secretion of thyroxin.
- 1.7 The maintenance of a constant internal environment in the body within certain limits.
- 1.8 The hormone responsible for osmoregulation.
- 1.9 The hormone that controls the concentration of water in the blood.
- 1.10 The hormone that increase the basic metabolic rate.
- 1.11 A gland of the digestive system that is both endocrine and exocrine.
- 1.12 The gland responsible for the production of the growth hormone.
- 1.13 The hormone which increases the absorption of glucose by the cells.
- 1.14 The system in the body that regulates processes by secreting hormones directly into the blood.
- 1.15 A hormone which stimulates secretion of the thyroid gland.
- 1.16 Glands that pour their secretion directly into the bloodstream.
- 1.17 Organ on which the adrenal glands are located.
- 1.18 Pancreatic secretion that increases the blood sugar levels

MATCH COLUMNS

Indicate whether each of the descriptions in COLUMN I apply to **A ONLY**, **B ONLY**, **BOTH A AND B** or **NONE** of the items in COLUMN II. Write **A only**, **B only**, **both A and B** or **none** next to the question numbers in the ANSWER BOOK

COLUMN I		COLUMN II
1.1.1	Condition affecting the cornea of the eye	A: Astigmatism B: Cataract
1.1.2	Nutrition provided by the egg	A: Ovipary B: Ovovivipary
1.1.3	The blood vessel that transports oxygenated blood from the placenta to the foetus	A: Umbilical vein B: Umbilical artery
1.1.4	A disorder caused by the degeneration of the myelin sheath of motor neurons	A: Multiple sclerosis B: Alzheimer's disease
1.1.5	The functional connection between two consecutive neurons	A: Receptor B: Synapse
1.1.6	The young develops and is nourished in an amniotic egg that is retained in the mother's body	A: Ovipary B: Vivipary
1.1.7	A reproductive strategy in vertebrates where internal fertilisation occurs	A: Altricial development B: Precocial development
1.1.8	The part of a neuron that speeds up the transmission of an impulse	A: Myelin sheath B: Axon
1.1.9	Female frogs lay eggs in water and the males spray sperm onto the eggs.	A: Vivipary B: Ovovivipary
1.1.10	The type of development in vertebrates where the young are well developed and able to move at birth	A: Precocial development B: Altricial development

COLUMN I		COLUMN II	
1.1.11	A type of development in birds in which offspring are poorly developed at birth and are thus unable to feed themselves	A:	Precocial development
		B:	Altricial development
1.1.12	Forms the placenta	A:	Chorionic villi
		B:	Endometrium
1.1.13	The state of the blood vessels in the skin of a human when the environmental temperature is high	A:	Constricted
		B:	Dilated
1.1.14	Plant hormone that stimulates the germination of seeds	A	Gibberellins
		B	Abscisic acid
1.1.15	Hormones secreted by the pituitary gland/hypophysis	A	Thyroxin
		B	FSH
1.1.16	Secretions from this gland contribute to the formation of semen	A	Cowper's gland
		B	Prostate gland
1.1.17	The hormone that is in excess in a person that grows abnormally tall	A	ADH
		B	Thyroxin
1.1.18	The part of the autonomic nervous system that controls involuntary actions	A	Sympathetic
		B	Parasympathetic
1.1.19	A hormone that controls the salt content in a human body	A	Adrenalin
		B	Aldosterone

DIAGRAMS (SHORT QUESTIONS)**REPRODUCTIVE STRATEGIES**

1.1 Study the diagram of one-day-old hatchlings **A** and **B** below. The diagram is not drawn to scale.

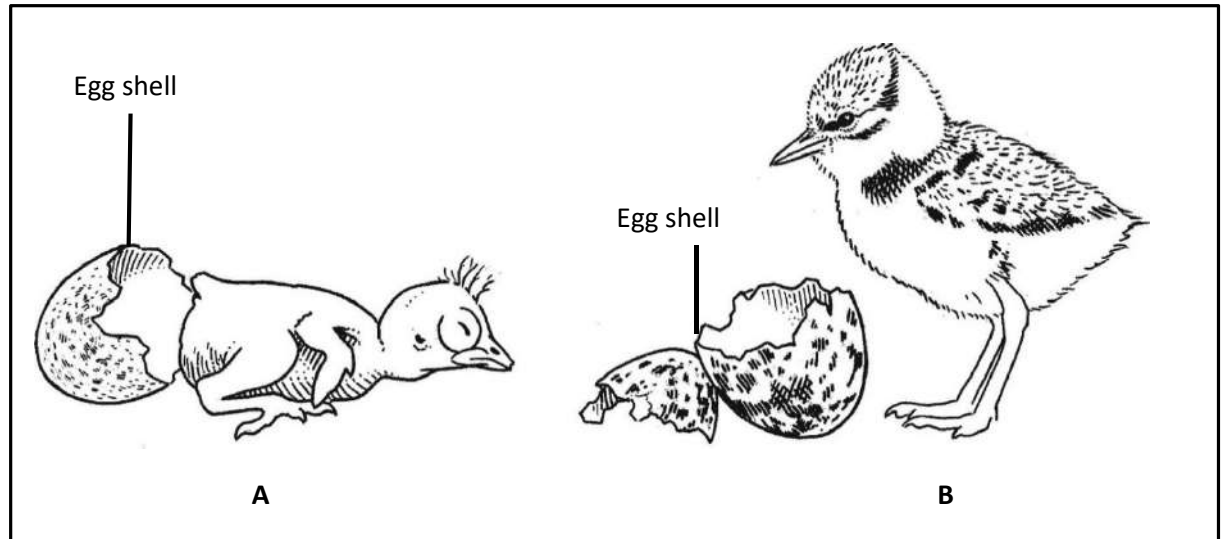

1.1.1 State TWO visible features in hatchling **A** which indicate altricial development. (2)

1.1.2 The diagram represents ovipary.

Explain ONE possible advantage of vivipary when compared to ovipary. (2)

1.1.3 Explain why you would expect that the yolk content of the egg of hatchling **B** was more than that of hatchling **A**. (2)

1.2

Guppy fish have a very interesting method of breeding. During mating the male deposits packets of sperm inside the female's reproductive opening using an organ called the 'gonopodium'. This process takes place several times and the female stores some of the extra sperm.

The fertilised eggs remain in the female's body until they hatch and the young are born live. The gestation period is usually between 22 and 28 days.

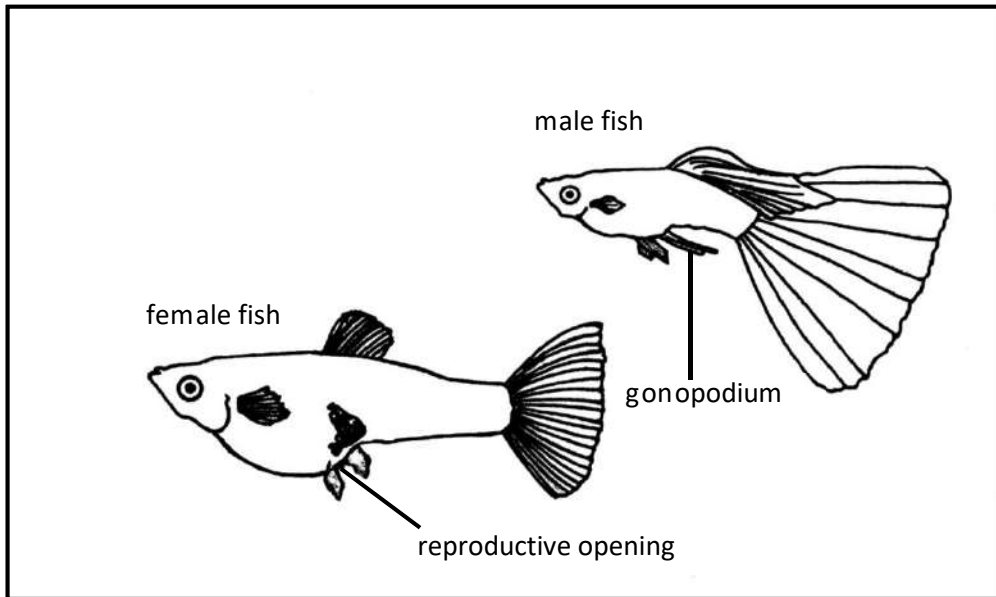

- 1.2.1 Name the type of fertilisation in guppies. (1)
- 1.2.2 Explain TWO ways in which the type of fertilisation named in QUESTION 1.2.1 increases reproductive success. (4)
- 1.2.3 Why are guppies regarded as being ovoviviparous? (2)

1.3 The diagrams below represent organisms with different reproductive strategies.

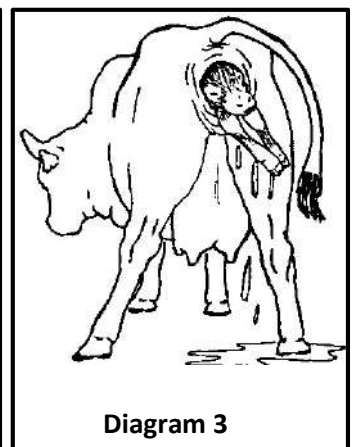
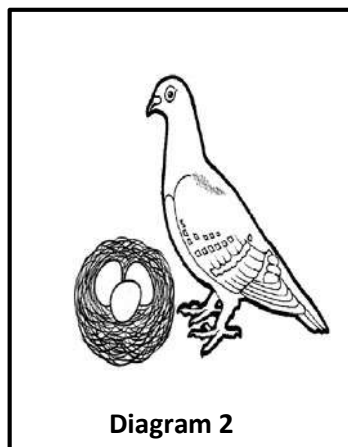
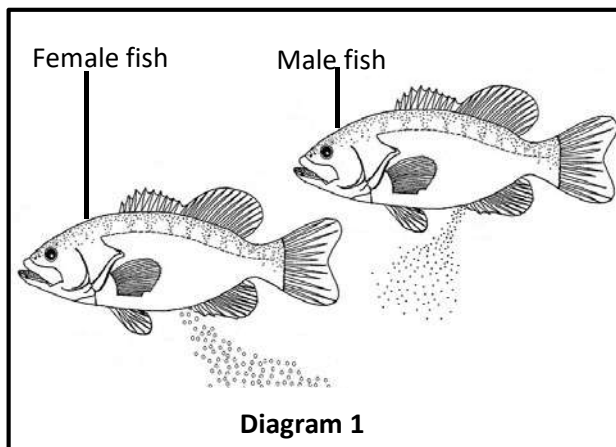

- 1.3.1 Which diagram(s) (1, 2 or 3) represent(s) organism(s):
- (a) Where external fertilisation takes place (1)
- (b) Where extra-embryonic membranes develop to assist with the protection and nutrition of the embryo (2)

(c) Which is/are oviparous (2)

1.3.2 Name the type of egg produced by the organism represented in Diagram 2. (1)

HUMAN REPRODUCTION

1.4 The diagram below represents a sequence of events that may take place inside the human female reproductive system.

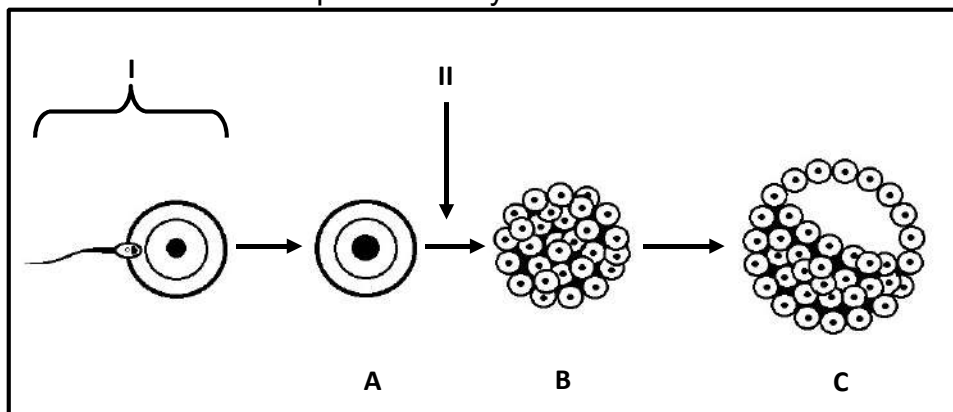

1.4.1 Identify the process taking place at I in the diagram above. (1)

1.4.2 State the type of cell division that takes place at II in the diagram above. (1)

1.4.3 Name TWO functional extra-embryonic membranes that are produced by structure C. (2)

1.4.4 Identify the stage of development indicated by:

(a) A (1)

(b) B (1)

(c) C (1)

1.4.5 Name the part of the female reproductive system where the events in the diagram above usually take place. (1)

1.4.6 Give the chromosome number of the cell at A if this cell is going to develop into a child with Down syndrome. (1)

1.5 The diagrams below represent the structures of an ovum and a sperm.

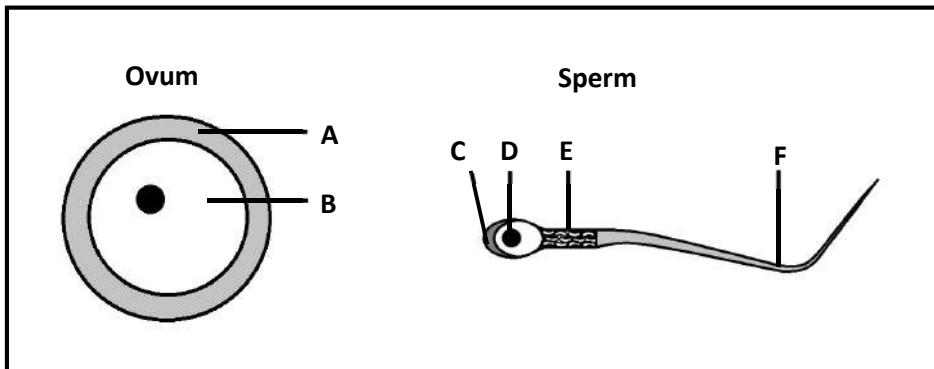

1.5.1 Identify part:

- (a) A (1)
- (b) B (1)
- (c) C (1)

1.5.2 Name the process involving meiosis that leads to the formation of an ovum. (1)

1.5.3 Write down only the LETTER of the part of the sperm that enters the ovum. (1)

1.5.4 Write down only the LETTERS of TWO parts that enable the sperm to move towards the ovum. (

1.6 The diagrams below show structures formed during human reproduction.

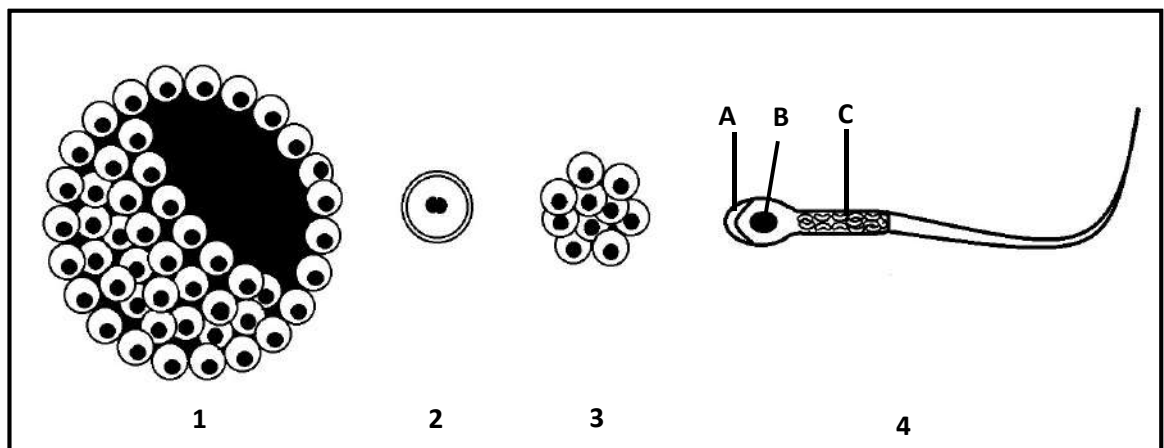

1.6.1 Identify part **A**. (1)

1.6.2 Name the organelle found in large numbers in part **C**. (1)

1.6.3 Give the NUMBER (**1, 2, 3** or **4**) only of the diagram that represents the following:

(a) Morula (1)

(b) Structure that will implant in the uterus (1)

(c) Blastula/Blastocyst (1)

1.6.4 Give the LETTER and NAME of the part that will enter the ovum during fertilisation. (2)

1.6.5 Name the type of cell division that occurred to produce the structure in diagram **3**. (1)

1.7 The schematic diagram below shows a human ovum that is about to be fertilised. The diagram is not drawn to scale.

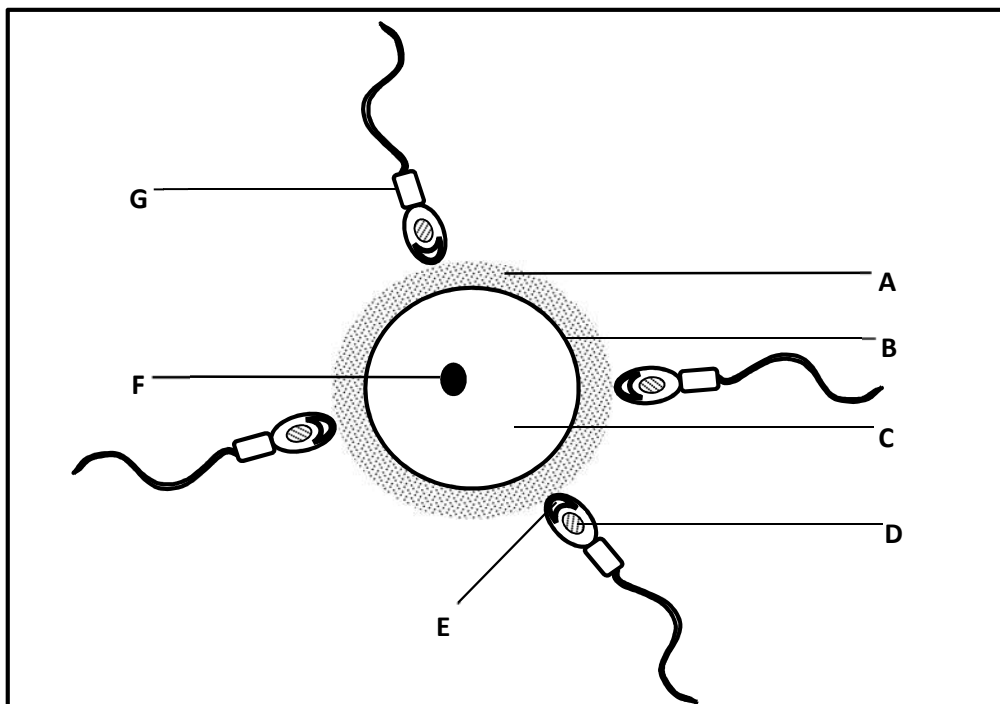

1.7.1 Identify part:

(a) **A** (1)

(b) **B** (1)

- (c) C (1)
- (d) F (1)

1.7.2 Give the LETTER and NAME of the part that:

- (a) Contains the mitochondria (2)
- (b) Contains enzymes required to penetrate the ovum (2)
- (c) Will enter the ovum during fertilisation (2)

1.8 The diagram below represents a part of the male reproductive system.

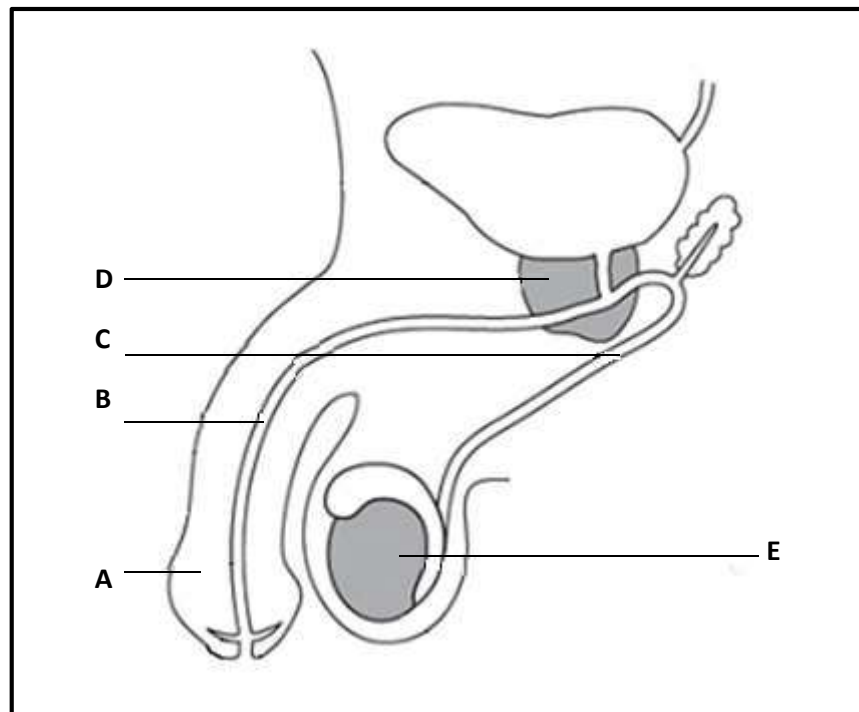

1.8.1 Give the LETTER and the NAME of the part that:

- (a) Is used in copulation (2)
- (b) Produces testosterone (2)

1.8.2 Give ONLY the LETTERS of the TWO parts in the diagram that:

- (a) Contribute to the formation of semen (2)
 - (b) Provide a passage for the sperm cells (2)
- (8)**

- 1.9 Study the diagram below of the sequence of events that takes place from the fertilisation of the ovum to the development of the embryo in a part of the human female reproductive system. The arrows indicate the direction of development of one ovum after fertilisation.

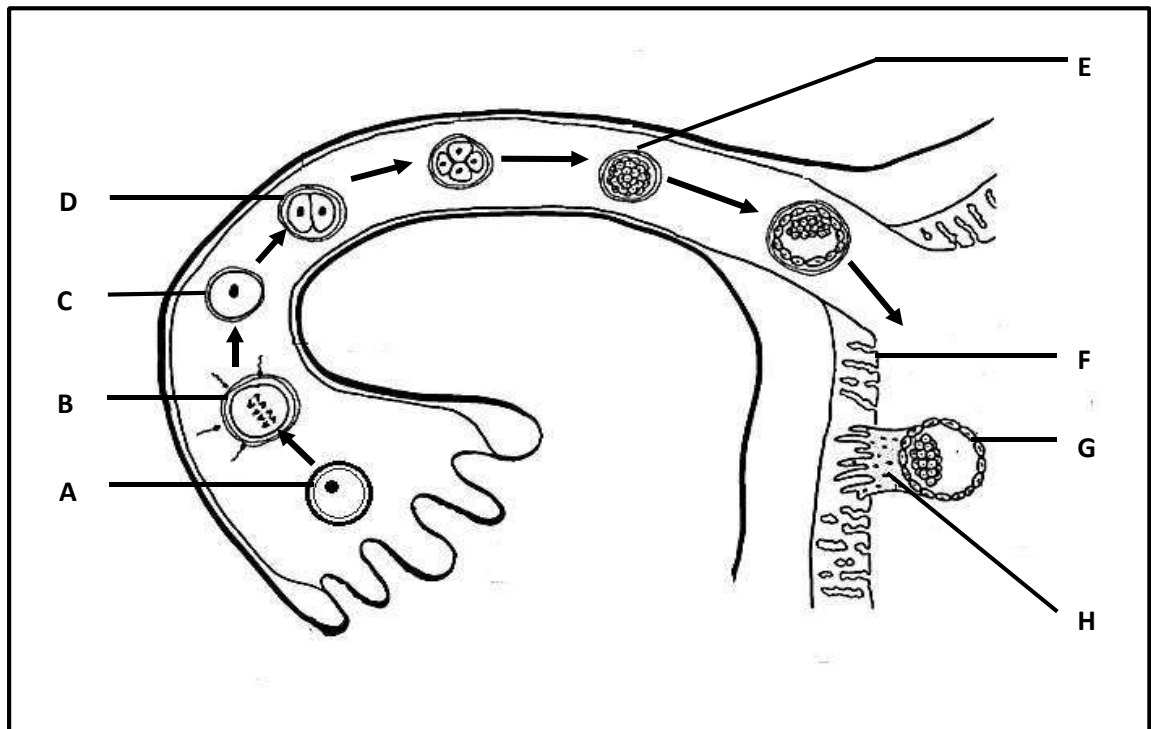

- 1.9.1 Identify:
- (a) Structure **C** (1)
- (b) The stage of embryo development at **E** (1)
- (c) The structure that develops from a combination of parts **F** and **H** (1)
- 1.9.2 Name the process that takes place:
- (a) At **B** (1)
- (b) When **G** attaches to part **F** (1)
- 1.9.3 Give the chromosome number of:
- (a) The cells at **D** (1)
- (b) Cell **A** (1)

HUMAN RESPONSE

- 1.1 The diagram below represents a human brain.

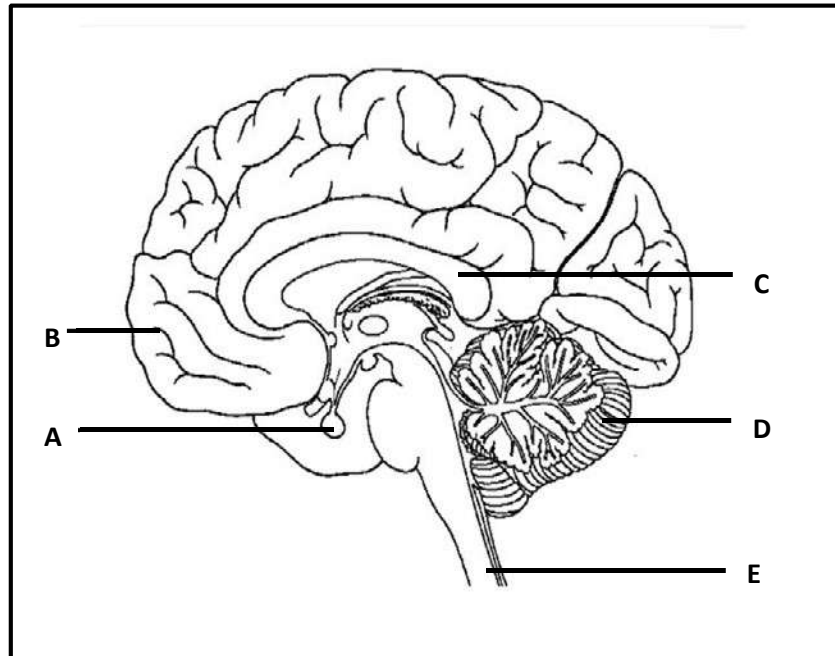

Give the LETTER and NAME of the part of the brain responsible for:

- 1.1.1 Memorising a cellular phone number (2)
- 1.1.2 Coordinating all voluntary movements (2)
- 1.1.3 Secreting hormones (2)
- 1.1.4 Connecting the two hemispheres of part **B** (2)
- 1.1.5 The reflex action that occurs when stepping barefooted on a sharp object (2)

1.2 The diagram below shows some parts of the human central nervous system.

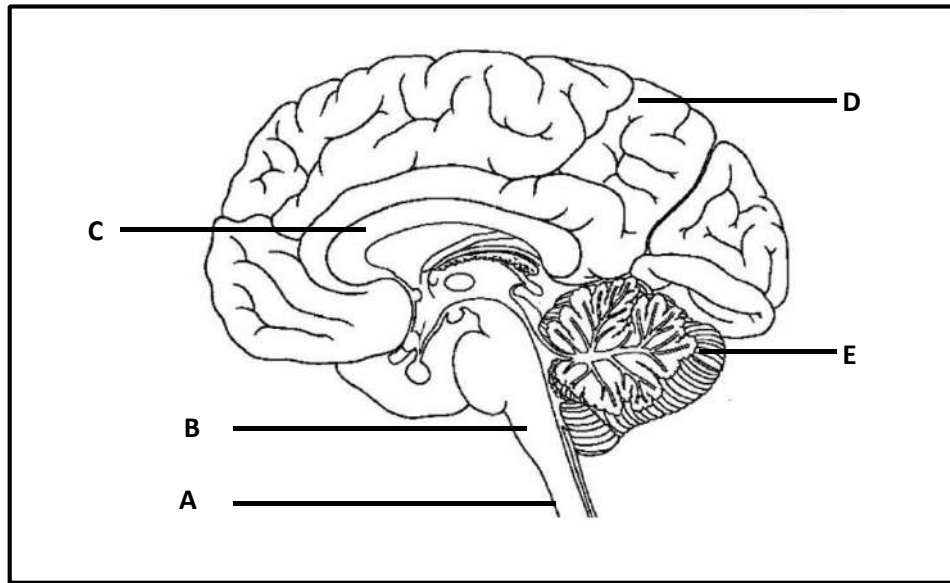

1.2.1 Identify part:

(a) **A** (1)

(b) **C** (1)

1.2.2 Write down the LETTER and NAME of the part that:

(a) Has the centre for interpreting taste (2)

(b) Regulates the heart rate (2)

(c) Is responsible for motor coordination (2)

1.3 The diagrams below show different neurons.

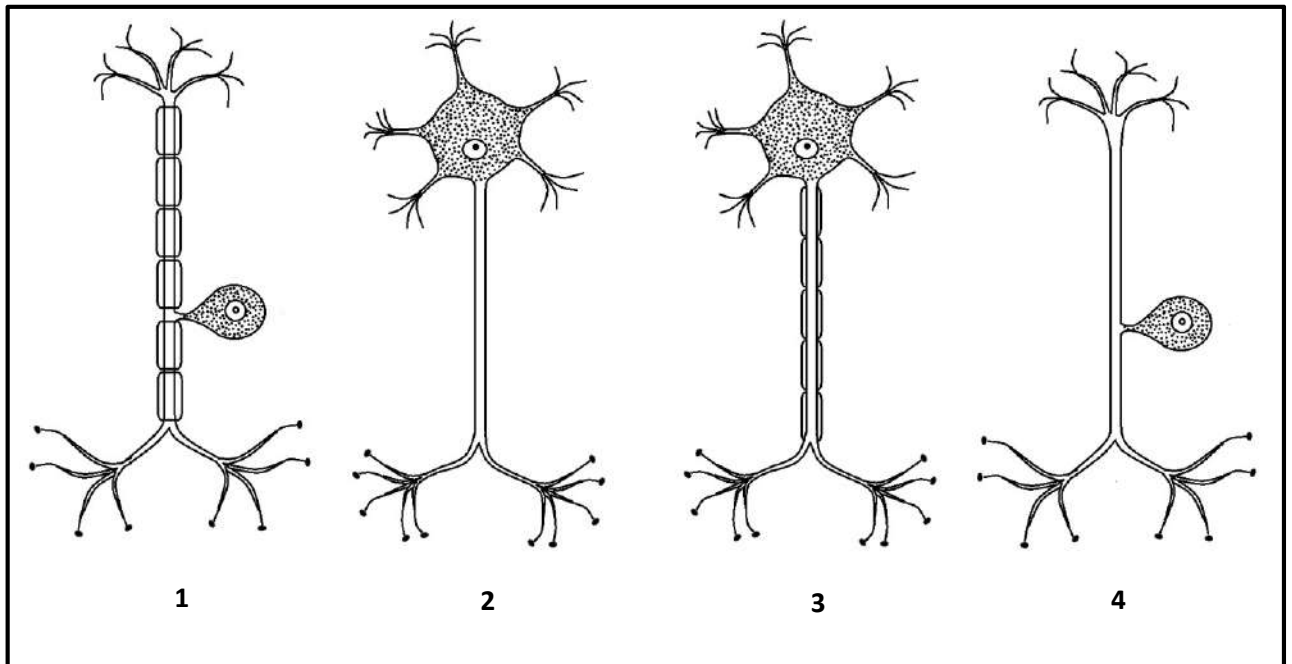

Give only the NUMBERS (1, 2, 3 or 4) of TWO neurons that:

- 1.3.1 Transport impulses from the receptor to the central nervous system (2)
- 1.3.2 Will have a faster transmission of impulses (2)
- 1.3.3 Are damaged if a person can feel the stimulus but is unable to react (2)

1.4 The diagram below represents a part of the human ear.

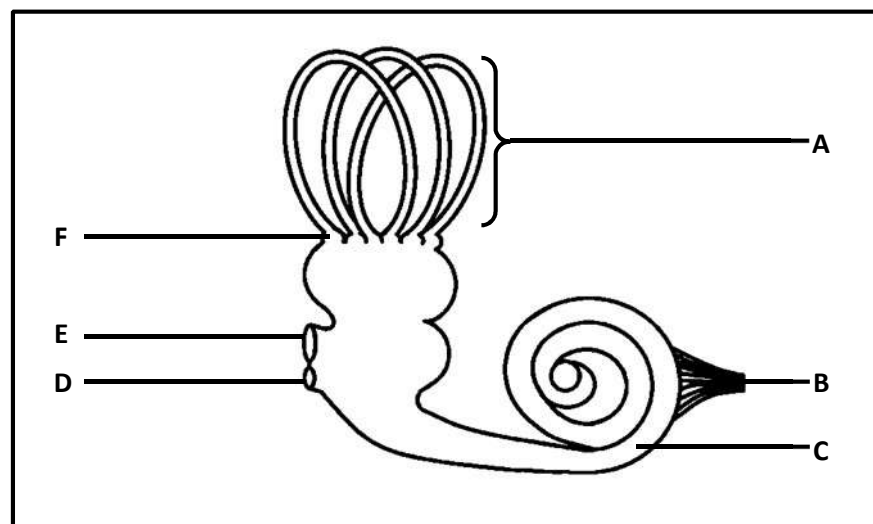

1.4.1 Identify part:

(a) **A** (1)

(b) **B** (1)

1.4.2 Give the LETTER and NAME of the part that:

(a) Creates pressure waves in the fluid of the inner ear (2)

(b) Absorbs excess pressure waves in the inner ear to prevent the formation of an echo (2)

1.4.3 Name the:

(a) Part of the brain that interprets impulses from part **F** (1)

(b) Receptors found at **C** (1)
(8)

1.5 A boy steps on a nail and pulls his leg away suddenly. The diagram below shows the pathway taken to create this reaction.

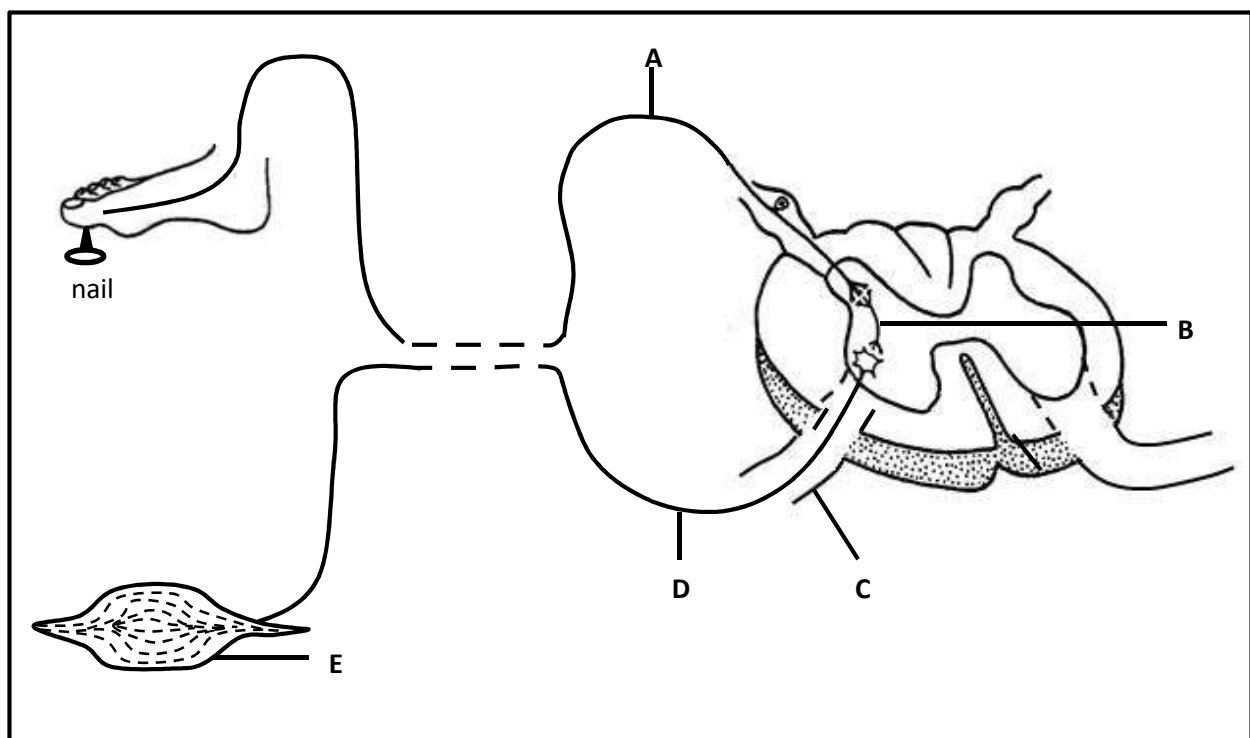

- 1.5.1 Name the pathway represented by the diagram. (1)
- 1.5.2 Give ONE advantage of this type of reaction. (1)
- 1.5.3 Identify part:
- (a) **B** (1)
- (b) **C** (1)
- (c) **E** (1)
- 1.5.4 Give the LETTER and NAME of the neuron that transports impulses towards the spinal cord. (2)

1.6 The diagram below shows a reflex arc.

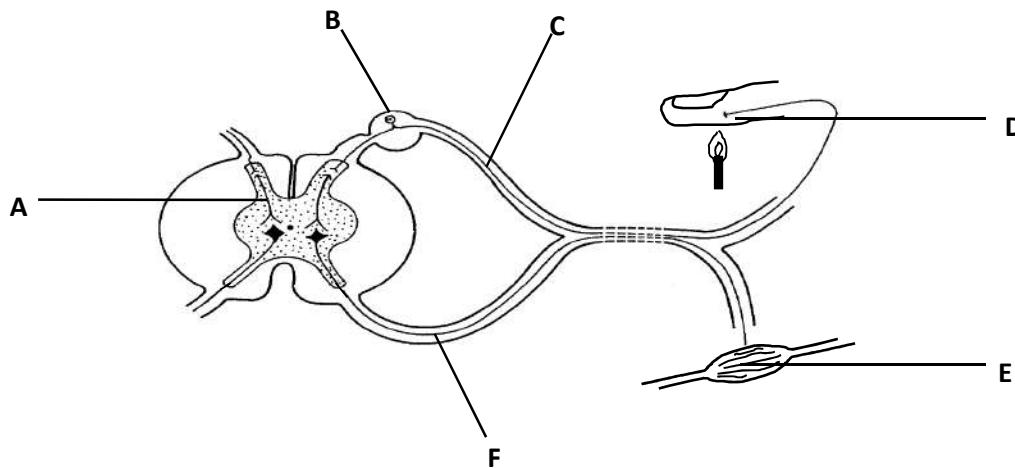

- 1.6.1 Give ONLY the LETTER of the part that represents the:
- (a) Effector (1)
- (b) Interneuron/Connector neuron (1)
- (c) Sensory neuron (1)
- 1.6.2 Give the LETTER and NAME of the neuron in the diagram that is probably damaged if a person is able to detect the stimulus, but cannot respond. (2)
- 1.6.3 State if the nerve impulse travels from **D** to **E** or from **E** to **D**. (1)
- (6)**

1.7 The diagram below represents a reflex arc.

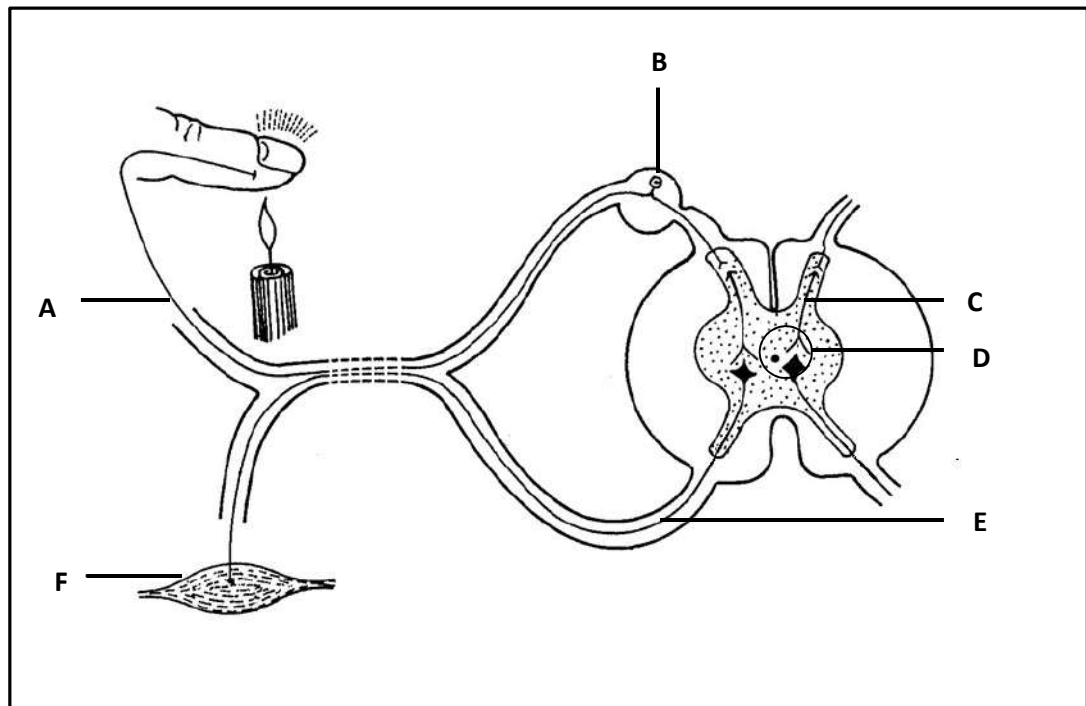

1.7.1 Give the LETTER and NAME of the part that:

(a) Controls one-directional transmission of impulses (2)

(b) Transmits impulses from the sensory neuron to the correct motor neuron (2)

(c) Transmits impulses to the cell body (2)

1.7.2 Give only the LETTER of the:

(a) Neuron that is damaged when a person is able to feel pain, but cannot react to the stimulus (1)

(b) Effector (1)

1.8 The diagram below represents a section through a human eye.

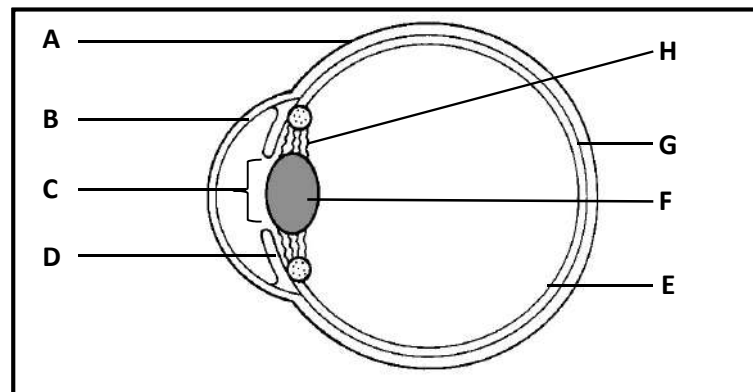

1.8.1 Identify:

- (a) **A** (1)
- (b) **B** (1)
- (c) **C** (1)

1.8.2 Give the LETTER and NAME of the part that:

- (a) Regulates the amount of light entering the eye (2)
- (b) Contains a dark pigment that absorbs excess light in the eye(2)
- (c) Contains receptors sensitive to light (2)

ENDOCRINE AND HOMEOSTASIS

1.1 The diagram below shows the hormones involved in the homeostatic control of metabolism in the human body. **X** is a gland found around the larynx in the neck.

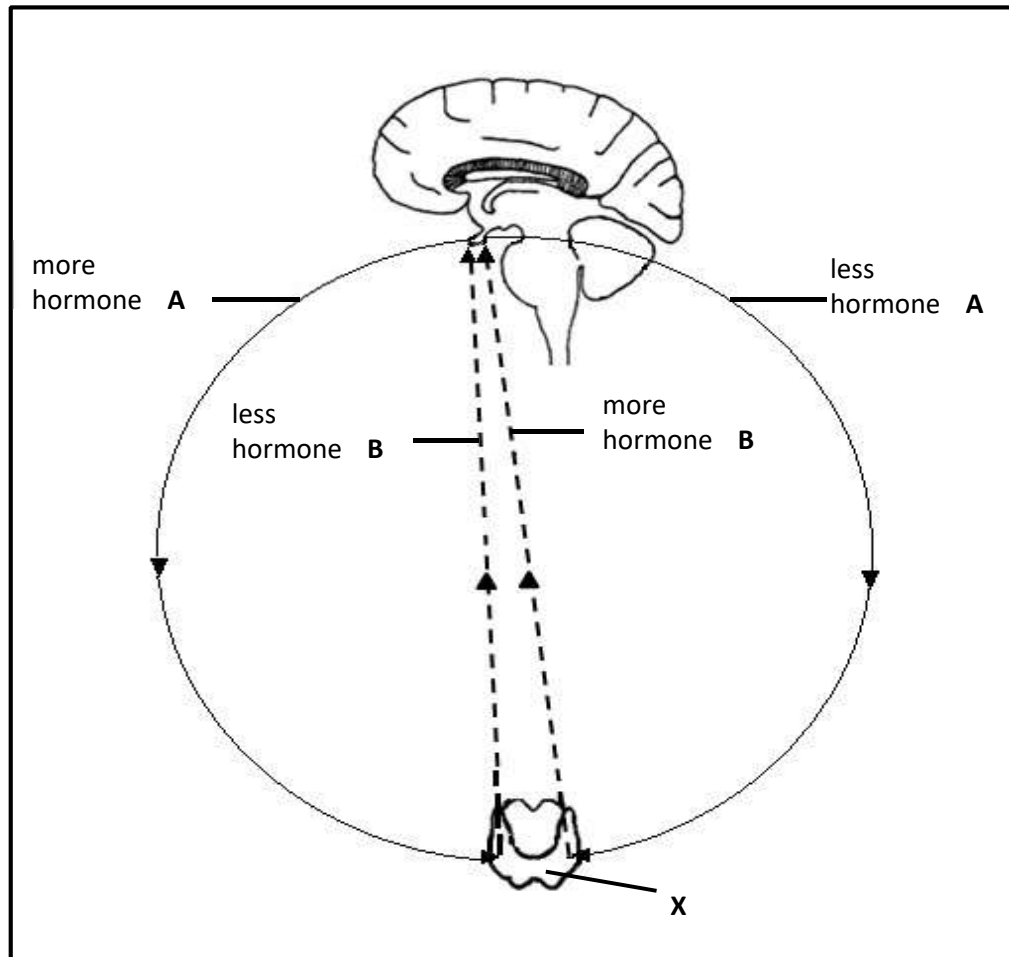

1.1.1 Identify EACH of the following:

- (a) The gland that secretes hormone **A** (1)
- (b) Hormone **B** (1)

1.1.2 Name the mechanism in the diagram that regulates the level of hormone **B**. (1)

1.1.3 Half of gland **X** was surgically removed in a person.

State TWO possible effects that this would have on the secretion of the hormones referred to in the diagram above. (2)